



UNITED BRASS WORKS, INC.
 714 S. Main St. Randleman, N.C. 27317
 Tel: 800-334-3035 Fax: 800-498-4696 www.ubw.com



Model 3050 1/2" Float Valve

**Max Inlet Water Pressure 50PSI
 Max Operating Temperature 350° F**

Bronze Body

Brass Piston

EPDM Disc & O-Ring

Contains Lead. Not Intend for Use in Potable Water Systems

Available Without Piston Ring as Part 3050FU



MATERIAL LIST

NO.	DESCRIPTION	MATERIAL
1	Body	Bronze
2	O-Ring	EPDM
3	Plunger	Brass
4	Disc	EPDM
5	Long Arm	Brass
6	Thumb Screw	Brass
7	Short Arm	Brass
8	Cotter Pin	Brass

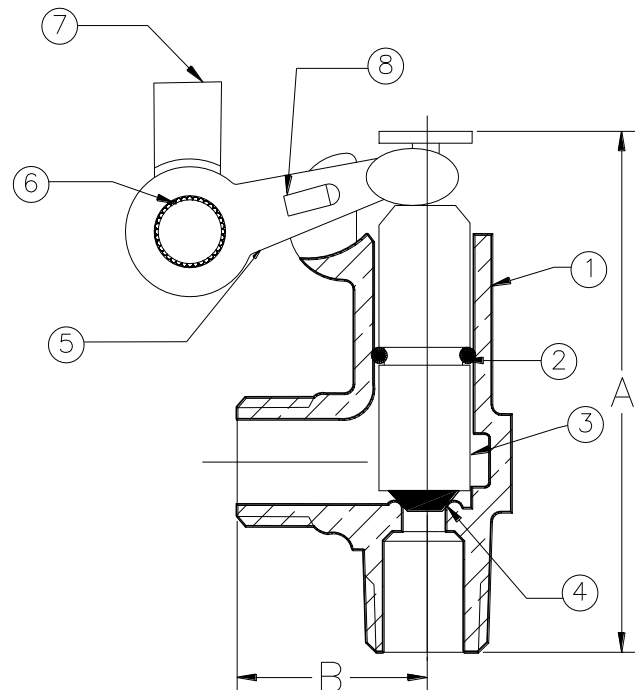

Size	1/2"
A	3.40
B	1.40
Ship Wt. (lbs.)	0.69
Qty. Per Carton	12